

SPECIFICATION SHEET

COLLECTION: CAMEO
PRODUCT CODE: CAM-131T-MB

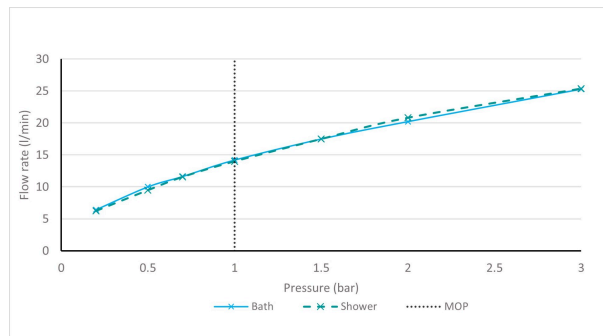
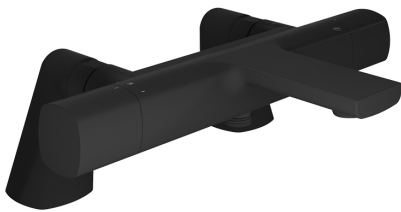

TAP TYPE

Bath Shower Mixer

WITH SHOWER KIT

No

WITH EASY-FIT BRACKETS

No

WITH INTEGRATED DIVERTER

No

WITH THERMOSTATIC TECHNOLOGY

Yes

FOR USE WITH BATH FILLER WASTE AND OVERFLOW

No

WITH BATH SPOUT

Yes

WITH AIR-INJECTION TECHNOLOGY

No

WITH WATER FLOW STRAIGHTENER

Yes

tel: 01934 744466
email: sales@vado.com
www.vado.com

WHERE INSPIRATION FLOWS
TAPS | SHOWERS | ACCESSORIES



SPECIFICATION SHEET

COLLECTION: CAMEO
PRODUCT CODE: CAM-131T-MB

WITH WATER FLOW AERATOR

No

CONNECTIONS / FITTINGS

2x 3/4" 50mm threaded connection on legs

HANDLES

2 Handle

SPARE PARTS

thermostatic cartridge V-704-34S

DECK HOLE DRILL DIAMETER

28-25mm

STYLE

Square

HOLES

2 Hole

MOUNTING

Deck Mounted

PLUMBING SYSTEM SUITABILITY

Combination Boiler

COLLECTION NAME

Cameo

FINISH

Matt Black

MINIMUM OPERATING PRESSURE

1.0 Bar MP

SPECIFICATION SHEET

COLLECTION: CAMEO
PRODUCT CODE: CAM-131T-MB

GUARANTEE
10 Year Guarantee

tel: 01934 744466
email: sales@vado.com
www.vado.com

WHERE INSPIRATION FLOWS
TAPS | SHOWERS | ACCESSORIES



TECHNICAL DRAWING

COLLECTION: CAMEO
PRODUCT CODE: CAM-131T-MB

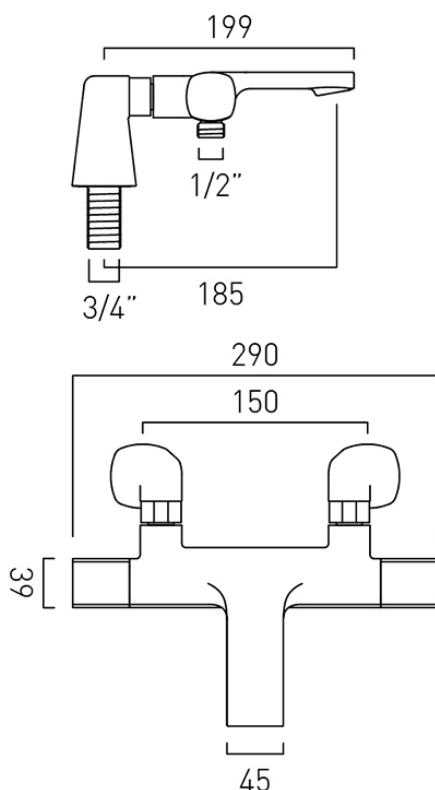

tel: 01934 744466
email: sales@vado.com
www.vado.com

WHERE INSPIRATION FLOWS
TAPS | SHOWERS | ACCESSORIES

