

# ALPHA

L 1700MM

W 750MM

	5MM	CARRONITE
ALPHA	✓	✓
L-SHAPED PANEL 1700x750x540	-	✓
FRONT PANEL 1700x540	✓	✓
END PANEL 750x540	✓	✓

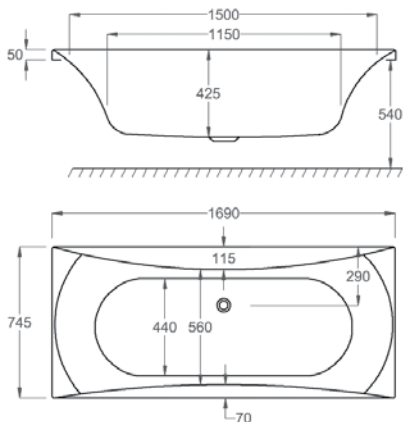

Carronite



Panel



Whirlpool

## WATER CAPACITY

175 LTR

This measurement is taken to the overflow

## WHIRLPOOL COMPATIBLE

C-LENDA SYSTEMS

1, 2, 3, 4, 5, 6

## KIT REFERENCES

STANDARD - AK-01

CARRONITE - AK-01-C