

DELTA

L 1675MM
W 700MM

	5MM	CARRONITE
DELTA	✓	✓
L-PANEL 1675x700x515	-	✓
FRONT PANEL 1675x515	✓	✓
END PANEL 700x515	✓	✓
SCREEN CFS-1 (H=1400MM)	✓	✓
SCREEN CFS-2 (H=1500MM)	✓	✓
GRIPS CCG-1	✓	✓

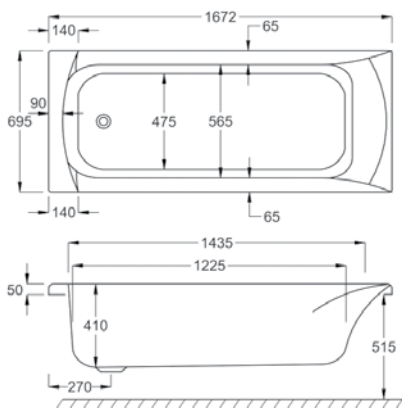

Carronite



Panel



Hand
Grips



Whirlpool

WATER CAPACITY

170 LTR

This measurement is taken to the overflow

WHIRLPOOL COMPATIBLE

C-LENDA SYSTEMS

1, 2, 3, 4, 5, 6

KIT REFERENCES

STANDARD - AK-01

CARRONITE - AK-01-C